



PUV-2608TX

Multi-format Switch with HDBaseT Output and USB Connectivity

OPERATION MANUAL

HDMI®
HIGH-DEFINITION MULTIMEDIA INTERFACE

The terms HDMI, HDMI High-Definition Multimedia Interface, and the HDMI Logo are trademarks or registered trademarks of HDMI Licensing Administrator, Inc.

DISCLAIMERS

The information in this manual has been carefully checked and is believed to be accurate. CYP (UK) Ltd assumes no responsibility for any infringements of patents or other rights of third parties which may result from its use.

CYP (UK) Ltd assumes no responsibility for any inaccuracies that may be contained in this document. CYP (UK) Ltd also makes no commitment to update or to keep current the information contained in this document.

CYP (UK) Ltd reserves the right to make improvements to this document and/or product at any time and without notice.

COPYRIGHT NOTICE

No part of this document may be reproduced, transmitted, transcribed, stored in a retrieval system, or any of its part translated into any language or computer file, in any form or by any means—electronic, mechanical, magnetic, optical, chemical, manual, or otherwise—without express written permission and consent from CYP (UK) Ltd.

© Copyright 2020 by CYP (UK) Ltd.

All Rights Reserved.

Version 1.1

TRADEMARK ACKNOWLEDGMENTS

All products or service names mentioned in this document may be trademarks of the companies with which they are associated.



SAFETY PRECAUTIONS

Please read all instructions before attempting to unpack, install or operate this equipment and before connecting the power supply. Please keep the following in mind as you unpack and install this equipment:

- Always follow basic safety precautions to reduce the risk of fire, electrical shock and injury to persons.
- To prevent fire or shock hazard, do not expose the unit to rain, moisture or install this product near water.
- Never spill liquid of any kind on or into this product.
- Never push an object of any kind into this product through any openings or empty slots in the unit, as you may damage parts inside the unit.
- Do not attach the power supply cabling to building surfaces.
- Use only the supplied power supply unit (PSU). Do not use the PSU if it is damaged.
- Do not allow anything to rest on the power cabling or allow any weight to be placed upon it or any person walk on it.
- To protect the unit from overheating, do not block any vents or openings in the unit housing that provide ventilation and allow for sufficient space for air to circulate around the unit.
- Please completely disconnect the power when the unit is not in use to avoid wasting electricity.

VERSION HISTORY

REV.	DATE	SUMMARY OF CHANGE
RDV1	2022/07/01	Preliminary release

CONTENTS

1. Introduction	1
2. Applications	1
3. Package Contents	2
4. System Requirements	2
5. Features	3
6. Operation Controls and Functions	4
6.1 Front Panel	4
6.2 Rear Panel.....	5
6.3 IR Cable Pinouts	6
6.4 RS-232 Pinout and Defaults	6
6.5 WebGUI Control	7
6.5.1 AV Switch Tab.....	9
6.5.2 USB Tab.....	10
6.5.3 Automation Tab.....	11
6.5.4 EDID Tab.....	13
6.5.5 Network Tab.....	15
6.5.6 System Tab	16
6.6 Telnet Control.....	17
6.7 Serial and Telnet Commands.....	17
7. Connection Diagram	38
8. Specifications	39
8.1 Technical Specifications	39
8.2 Video Specifications.....	41
8.3 Audio Specifications.....	43
8.3.1 Digital Audio	43
8.3.2 Analog Audio	43
8.4 Cable Specifications	44
8.5 HDBaseT Features.....	45
9. Acronyms.....	46



1. INTRODUCTION

This UHD⁺ Multi Format to HDBaseT Switch is an HDMI, DisplayPort, and USB-C switch with audio embedding and HDBaseT output. This unit can send high definition uncompressed audio/video along with Ethernet, USB, IR, and RS-232 over a single Cat.6A cable up to a distance of 100 meters. The HDMI, DisplayPort, and USB-C inputs all support resolutions up to 4K@60Hz (4:4:4, 8-bit). With the use of the 3.5mm audio input, stereo audio may be embedded into the HDBaseT output as well. Despite HDBaseT's 10.2Gbps bandwidth limitation, high bandwidth 4K UHD⁺ HDMI video sources, up to and including 4K@60Hz (4:4:4, 8-bit), can be supported and will be automatically scaled down to 1080p when necessary.

When paired with this unit's standard receiver, a total of 3 selectable USB host (Type-B/C) connections are available which provide access to 5 USB device (Type-A) ports forming a highly flexible KVM extension configuration (Note: Only 1 USB host may be active at a time). Additionally, the USB Type-C input can provide power (up to 60W) to any connected device (only available when the unit is powered locally). All USB ports on the transmitter support up to USB 3.0 data transfer speeds.

Signal management features, such as automatic source switching based on input signal detection, enable convenient hands-free operation. Additional functionality such as advanced EDID management, HDCP management, and basic signal event automation (which can automatically send customised RS-232 or CEC commands to an external device) are also available.

The unit can be powered locally with a 24V power supply, or remotely via PoH (Power over HDBaseT) from a compatible HDBaseT receiver, which allows for greater flexibility in installations. It can be controlled via the front panel button, WebGUI, Telnet, and RS-232.

2. APPLICATIONS

- /// Household entertainment sharing and control
- /// Lecture halls, auditoriums, and classrooms
- /// Conference rooms and boardrooms
- /// Hotel event spaces

3. PACKAGE CONTENTS

- /// 1× UHD⁺ Multi-Format to HDBaseT Switcher
- /// 1× 24V/3.75A DC Power Adapter
- /// 1× Power cable
- /// 1× IR Blaster
- /// 1× IR Extender
- /// 2× Terminal Block (3-pin)
- /// 1× Shockproof Feet (Set of 4)
- /// 1× Operation Manual

4. SYSTEM REQUIREMENTS

- /// HDMI, DisplayPort, or USB Type-C source equipment such as media players, video game consoles, or set-top boxes.
- /// A compatible HDBaseT receiver with PoH (PSE) support is recommended.
- /// The use of Premium High Speed HDMI cables, and industry standard Cat.6, Cat.6A, or Cat.7 Ethernet cable is highly recommended.
- /// The use of 30AWG (Gen 2) USB Type-C cable is highly recommended.
- /// The use of DisplayPort 1.2 or higher spec cable is highly recommended.

5. FEATURES

- /// HDMI 2.0, DisplayPort 1.4, USB-C, and DVI 1.0 compliant
- /// HDCP 1.x and 2.2 compliant
- /// 2 HDMI, 1 DisplayPort, 1 USB Type-C video input, and a 3.5mm mini-jack analog audio input
- /// 1 HDBaseT output
- /// Supports up to 4K UHD⁺ (18Gbps, 4K@60Hz 4:4:4, 8-bit) video input
- /// Supports Deep Colour input up to 12-bit
- /// Supports 10-bit and 12-bit HDR (High Dynamic Range) input
- /// HDBaseT output supports resolutions up to 4K@60Hz (4:2:0, 8-bit) with automatic down conversion to 1080p for any sources that exceed HDBaseT's bandwidth limitations, such as 4K@60Hz (4:4:4, 8-bit) or 4K@any (10/12-bit) sources
- /// Supported HDBaseT feature set: HD Video & Audio, PoH (PD), and Control Extension (Bi-directional IR/RS-232/USB)
- /// Supports pass-through of many audio formats including 8 channel LPCM, Bitstream, and HD Bitstream
- /// Analog audio may be embedded with all sources
- /// USB Type-C input can provide power (up to 60W) to any connected device (only available when the unit is powered locally)
- /// Per-input EDID management with internal or external EDID options
- /// Supports manual input selection or automatic input selection with hot plug detection
- /// Basic signal event automation (via RS-232 or CEC)
- /// Supports optionally being powered via PoH from a compatible HDBaseT receiver
- /// Controllable via front panel button, WebGUI, Telnet, or RS-232

6. OPERATION CONTROLS AND FUNCTIONS

6.1 Front Panel

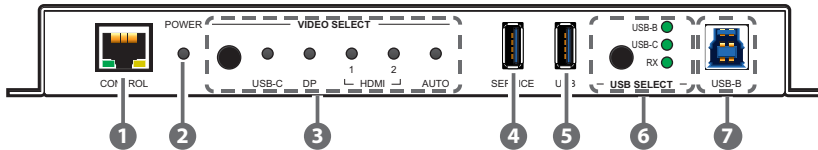

- 1 CONTROL Port:** Connect directly, or through a network switch, to your PC/laptop to control the unit via Telnet/WebGUI and to extend the network across the HDBaseT connection.
 - 2 POWER LED:** This LED will illuminate to indicate the unit is on and receiving power.
 - 3 VIDEO SELECT Button & LEDs:** Press the Video Select button to sequentially switch through the available inputs. The currently selected input's LED will illuminate green. The LEDs will illuminate red to indicate inputs that have live sources but are not currently selected. The Auto LED will illuminate when automatic routing is active.
 - 4 SERVICE/USB (Type-A) Device Port:** Connect directly to standard USB devices such as a mouse, keyboard, or flash drive to extend their USB functionality to the currently active USB host port. This port is also reserved for firmware update use.
 - 5 USB (Type-A) Device Port:** Connect directly to standard USB devices such as a mouse, keyboard or flash drive to extend their USB functionality to the currently active USB host port.
 - 6 USB SELECT Button & LEDs:** Press this button to select between the USB-B/USB-C Host Ports on the transmitter and the Host Port on a connected compatible receiver. The LED will illuminate to indicate which USB Host Port is currently selected.
- Note: Changing the USB host will force the HDBaseT connection to briefly disconnect while it reconfigures. The connected host (PC, laptop, etc.) may also take a moment to detect all available devices.*
- 7 USB-B (Type-B) Host Port:** Connect directly to a standard USB host, such as a PC or laptop, to extend its USB functionality to all currently connected USB devices.

Note: Multiple USB hosts may be connected at once (up to 3 total, between the Tx and a compatible Rx unit) with a single selected host active at a time.

6.2 Rear Panel

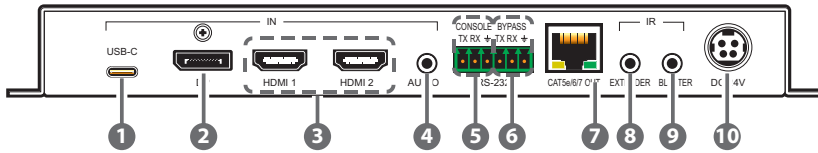

- 1 USB-C IN Port:** Connect to USB Type-C video source or USB host equipment such as a PC or laptop.

Note: 60W of power can be provided to connected USB-C devices, but only when the unit is powered locally. Due to its support of full USB 3.0 data transfer speeds, video bandwidth is limited to UHD.
- 2 DP IN Port:** Connect to DisplayPort source equipment such as a PC or laptop.
- 3 HDMI 1~2 IN Ports:** Connect to HDMI source equipment such as media players, game consoles, or set-top boxes.
- 4 AUDIO IN Port:** Connect to the stereo analog output of a device such as a CD player or PC for embedding into the HDBaseT output.
- 5 RS-232 CONSOLE 3-pin Terminal Block:** Connect directly to a PC, laptop, or other serial control device with a 3-pin adapter cable to send RS-232 commands to control the unit.
- 6 RS-232 BYPASS 3-pin Terminal Block:** Connect to a PC, laptop, or other serial control device with a 3-pin adapter cable for the extension of RS-232 signals to the other end of the HDBaseT connection.

Note: The bypass port's transmission settings are configured via the RS-232 automation tab. (See section 6.5.3)
- 7 CAT.5e/6/7 OUT Port:** Connect to a compatible HDBaseT receiver with a single Cat.5e/6/7 cable for transmission of all data signals. Power via PoH will also be supplied to this unit when connected to a compatible PSE receiver.
- 8 IR IN Port:** Connect to an IR Extender to receive IR control signals and extend them to devices connected to the other end of the HDBaseT connection. Ensure that the remote being used is within direct line-of-sight of the IR Extender.
- 9 IR OUT Port:** Connect to the provided IR Blaster to transmit IR signals from the other end of the HDBaseT connection to devices within direct line-of-sight of the IR Blaster.
- 10 DC 24V Port:** Plug the 24V DC power adapter into this port and connect it to an AC wall outlet for power. (Optional, if powered via PoH)

6.3 IR Cable Pinouts

IR Blaster Cable

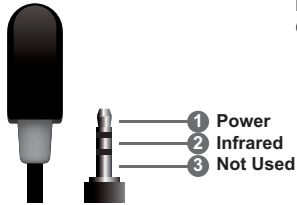

IR Extender Cable

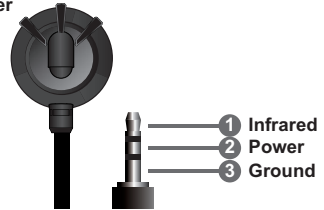

6.4 RS-232 Pinout and Defaults

Serial Port Default Settings	
Baud Rate	19200
Data Bits	8
Parity Bits	None
Stop Bits	1
Flow Control	None

3-pin Terminal Block

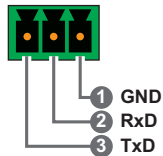

6.5 WebGUI Control

Device Discovery

Please obtain the “Device Discovery” software from your authorised dealer and save it in a directory where you can easily find it.

Connect the unit and your PC/Laptop to the same active network and execute the “Device Discovery” software. Click on “Find Devices on Internet” and a list of devices connected to the local network will show up indicating their current IP address.

Note: This unit defaults to DHCP mode. The current IP address can be verified via RS-232 if the Device Discovery software is not available.

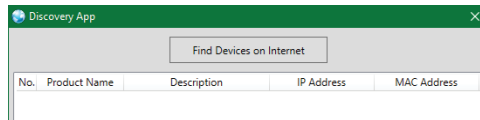

By clicking on one of the listed devices you will be presented with the network details of that particular device.

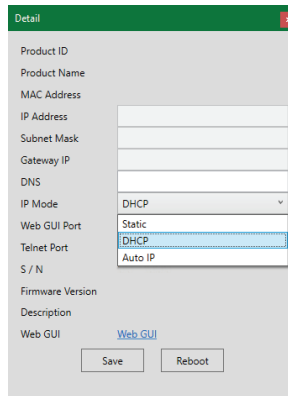

- 1) **IP Mode:** If you choose, you can alter the static IP network settings for the device, or switch the unit into DHCP mode to automatically obtain proper network settings from a local DHCP server. To switch to DHCP mode, please select DHCP from the IP mode drop-down, then click “Save” followed by “Reboot”.
- 2) **WebGUI Hotkey:** Once you are satisfied with the network settings, you may use them to connect via Telnet or WebGUI. The network

information window provides a convenient link to launch the WebGUI directly.

WebGUI Overview

After connecting to the WebGUI's address in a web browser, the login screen will appear. Please enter the appropriate user name and password then click "Submit" to log in.

Note: The default user name and password is "admin".

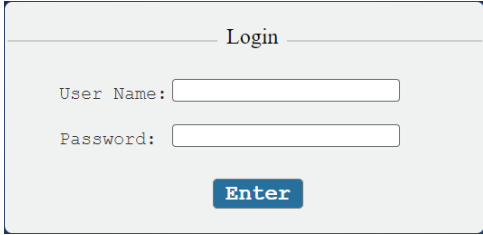

The image shows a login form titled "Login". It contains two input fields: "User Name:" and "Password:". Below the fields is a blue button labeled "Enter".

On the left side of the browser you will see the following menu tabs where all primary functions of the unit are controllable via the built in WebGUI. The individual functions will be introduced in the following sections.



Clicking the red "Logout" tab will automatically log the currently connected user out of the WebGUI and return to login page.

6.5.1 AV Switch Tab

This tab provides video/audio routing control as well as control over HDCP behavior, and naming of the inputs and output. To assign a new video route, please click the output button and then click on the button of the preferred input port to route. As you select each button they will change their colour to orange. The new routing will become active immediately and the routing information displayed on the buttons will change accordingly. Alternately, to change the audio that is paired with the video output, click on the Audio Output button on the bottom left.

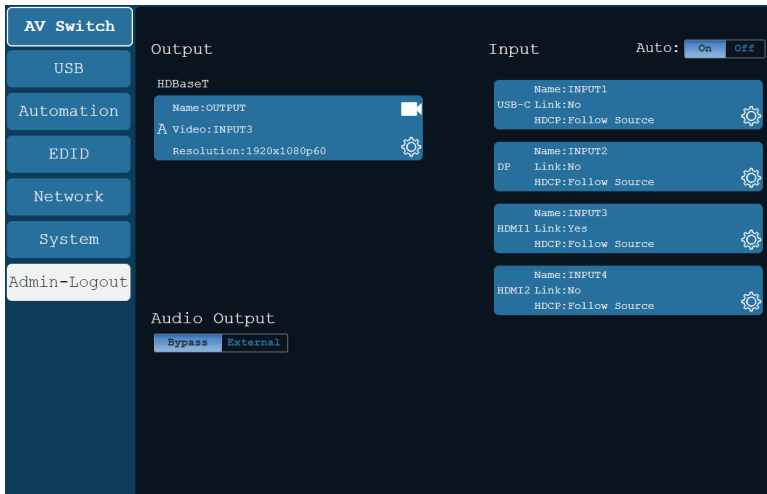

- 1) **Output:** This button selects the output to route A/V Inputs to. Details about the output name and currently selected Input are also displayed here. Clicking on the “Edit” icon (⚙️) opens up the Output Edit window. Clicking on the “A/V Mask” icon (🔇) will mute or unmute the audio and video output.
- 2) **Output Edit:** This window provides an option to rename the output.
 - **Set Output Name:** To rename the output, type the new name in the space provided in the Edit window. The name can be up to 32 characters long. Click the “Save” button to confirm the change.
- 3) **Auto:** Auto switching may be enabled or disabled by clicking on the On/Off slider to toggle the setting.
- 4) **Input 1~4:** Buttons for selecting the input to route to the output. To assign a new video route, click the output button followed by the button of the preferred input port to route. The new routing

will become active immediately. Details about the input names and current sync/HDCP settings are also displayed here. Clicking on the “Edit” icon (⚙️) opens up the Input Edit window.

- 5) **Audio Output:** Click on this toggle switch to select between outputting the source video’s original audio (Bypass) or the external analog audio source.

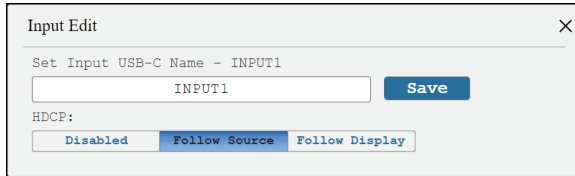

- 6) **Input Edit:** Provides Individual control over the name and the behavior of HDCP on each input.
 - **Set Input Name:** To rename an input, type the new name in the space provided in the Edit window. The name can be up to 32 characters long. Click the “Save” button to confirm the change.
 - **HDCP:** The HDCP mode of each input can be set to “Follow Source”, “Follow Display”, or “Disabled”. Changes made to this setting occur immediately.

6.5.2 USB Tab

This tab provides a way to select which USB Host Port is currently active.

Note: Changing the USB host to or from the Remote Host will force the HDBaseT connection to briefly disconnect while it reconfigures. The connected host (PC, Laptop, etc.) may also take a moment to detect all available devices.

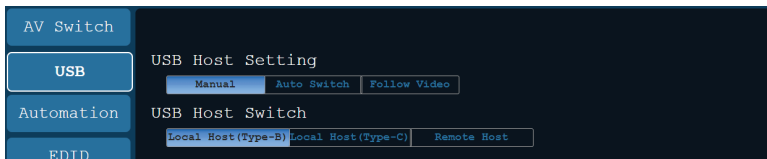

- 1) **Set USB Mode:** Select the preferred USB Host Port, from the displayed choices, to use as the currently active connection. The change will occur immediately and all USB Device Ports (USB Type-A) on the transmitter and receiver will connect to the new host.

6.5.3 Automation Tab

The Automation tab provides control over the unit's automatic control command broadcast behavior when any of the specified Automation Events occur. Automation commands may be sent to 3rd party devices via standard CEC, or customizable RS-232.

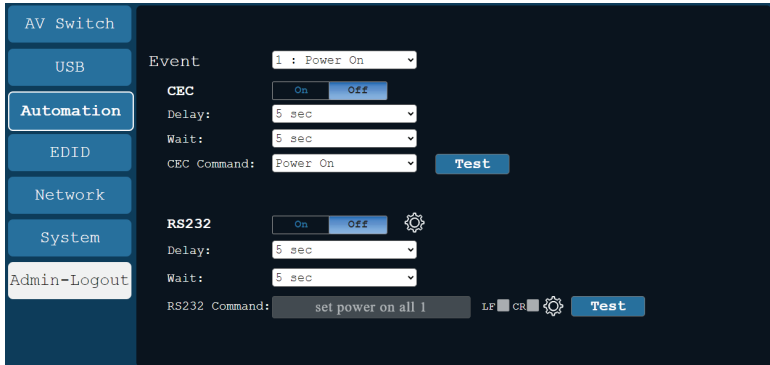

- 1) **Event:** Use the dropdown to select the Automation Event to configure. Available Automation Events are:
 - Power On: This unit is powered on.
 - Out A Source Active: The currently selected input changes from inactive to active.
 - Out A Source Lost: The currently selected input changes from active to inactive.
- 2) **CEC:** Enable or disable sending a CEC command when the currently selected Automation Event is activated.

Note: CEC support must also be enabled on the connected HDMI display device.

- **Delay:** Set the length of time, in seconds, that the specified Automation Event must continue to be true before sending the defined CEC command.
- **Wait:** Set the length of time, in seconds, to wait after this Automation Event has been activated before ANY other Automation Event can be detected.
- **CEC Command:** Set the CEC command to send when the specified Automation Event is activated. Click the "Test" button to send the command immediately. Available CEC commands are:
 - Power On: Turn on the connected HDMI display device.

- Power Off: Turn off the connected HDMI display device.
- Active Source: Force the connected HDMI display device to switch to the HDMI input that this unit is connected to.
- Power On + Active Source: Turn on the connected HDMI display device and force the connected HDMI display device to switch to the HDMI input that this unit is connected to.

Note: Not all HDMI devices support all CEC commands.

- 3) **RS-232:** Enable or disable sending a RS-232 command when the currently selected Automation Event is activated. Click the “Edit” icon (✎) to configure the various RS-232 port settings including baud rate, data length, parity and stop bits.

Note: RS-232 commands will be sent across the bypass RS-232 ports on both the transmitter and receiver.

- **Delay:** Set the length of time, in seconds, that the specified Automation Event must continue to be true before sending the defined RS-232 command.
- **Wait:** Set the length of time, in seconds, to wait after this Automation Event has been activated before ANY other Automation Event can be detected.
- **RS-232 Command:** Displays the currently defined RS-232 command text. Click on the “Edit” icon (✎) to define the RS-232 command to send when the specified Automation Event is activated. Click the “Test” button to send the command immediately.

6.5.4 EDID Tab

This tab provides control over the EDID behavior of the unit. There are six internal EDIDs, four customer uploaded EDIDs, and one sink sourced EDID that can be assigned to a single input, or to all 4 as a group. The sink EDID and Customer EDIDs are also available for download to the connected PC.

Note: UHD+ EDIDs cannot be applied to the USB-C input due to bandwidth limitations.



1) User EDID:

- **Upload:** To upload a User EDID, select the User EDID slot to upload into from the dropdown list and then click the “Upload” button. An EDID Upload window will appear, allowing you to locate and upload the preferred EDID file (*.bin format) from a local PC. Once the correct file has been selected, please click the “Upload” button in the window, and the file will be transferred to the unit.
- **Download:** To save an existing User EDID to your local PC, select the User EDID slot from the dropdown list and then press the “Download” button. Depending on your browser settings you will either be asked where to save the downloaded file, or the file will be transferred to the default download location on your PC.
- **Edit Name:** Click the “Edit Name” button to open a window that allows changing the name of the currently selected User EDID. Click the “Save” button within the window to confirm the change.

2) Output EDID:

- **Download:** To save the EDID from the connected display to your local PC, select the sink from the dropdown list then press the “Download” button. Depending on your browser settings you will either be asked where to save the downloaded file, or the file will be transferred directly to the default download location on your PC.

3) Input EDID: This section provides controls for assigning a new EDID to one, or all inputs within the system.

- **Appoint/All:** Selecting “All” will allow the assignment of a single EDID to all inputs simultaneously. Selecting “Appoint” allows for a different EDID to be assigned to each individual input.
- **EDID Selection:** Click on the input button on the left to open the EDID Table List window. Select the new EDID source to use and the change will occur immediately across all selected inputs.

Note: In most cases, assigning a new EDID to an input will cause the affected inputs to briefly blink out while the source adapts to the new information.

This unit provides the following 6 default EDIDs:

Unit's default EDIDs	
FHD 2CH	1920×1080p@60Hz (4.95Gbps), 8-bit colour, LPCM 2.0
FHD MCH	1920×1080p@60Hz (4.95Gbps), 8-bit colour, LPCM 7.1 & Bitstream
UHD 2CH	3840×2160p@30Hz (10.2Gbps), 12-bit Deep Colour, LPCM 2.0
UHD MCH	3840×2160p@30Hz (10.2Gbps), 12-bit Deep Colour, LPCM 7.1 & Bitstream
UHD+ 2CH	3840×2160p@60Hz (18Gbps), 12-bit Deep Colour, LPCM 2.0
UHD+ MCH	3840×2160p@60Hz (18Gbps), 12-bit Deep Colour, LPCM 7.1 & Bitstream

Note: In some rare cases it is possible for custom or external EDIDs to cause compatibility issues with certain sources. If this happens, it is recommended to switch to one of the 6 default EDIDs for maximum compatibility.

6.5.5 Network Tab

This tab provides network configuration options including changing the IP mode, viewing/setting the IP configuration, changing the admin login password, and changing the Web Login timeout.

Note: This unit's network defaults to DHCP mode.

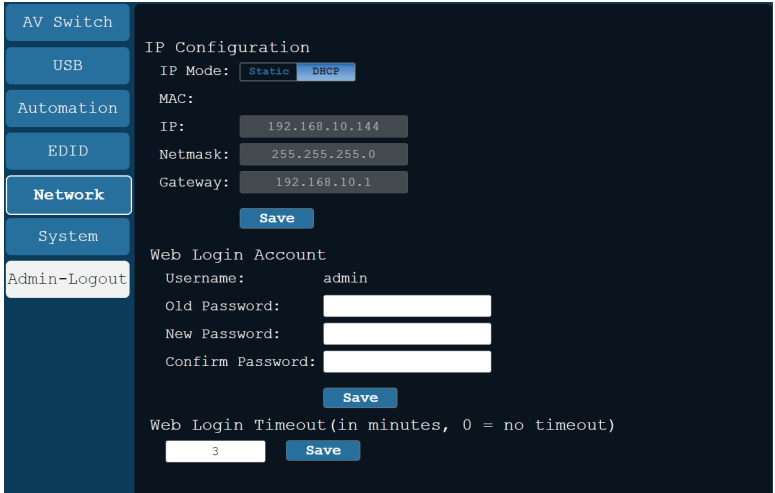

- 1) **IP Configuration:** IP Mode may be switched between Static IP or DHCP. In Static IP Mode the IP, netmask and gateway addresses must be manually set. When in DHCP Mode, the unit will attempt to connect to a local DHCP server and obtain IP, netmask and gateway addresses automatically. Please press “Save” after making any changes to the IP configuration or mode.

Note: If the IP address is changed then the IP address required for WebGUI/Telnet access will also change accordingly.

- 2) **Web Login Account:** The WebGUI’s admin password can be changed here. Please press “Save” after entering the old and new passwords to enact the change.

Note: The default password is “admin”.

- 3) **Web Login Timeout:** Select the length of time to wait before logging the user out of the WebGUI due to inactivity. Available range is from 0 to 35970 minutes. Setting it to 0 will disable the timeout function.

6.5.6 System Tab

This tab provides system configuration backup/restore options, controls to perform a factory reset or system reboot, firmware update support, as well as displaying the unit's serial number.

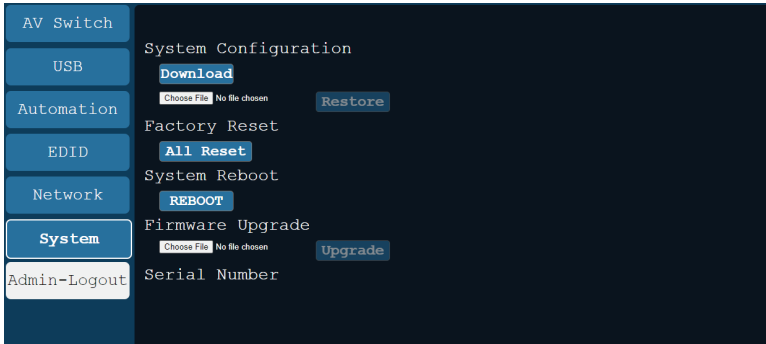

1) System Configuration

- **Download:** The current system configuration, including routing and settings, may be saved as an XML file to a PC. Click the “Download” button to save the current system configuration to your local PC.
- **Restore:** Previously saved system configurations may be restored from a saved XML file. Click the “Choose File” button to locate the saved XML file, then click the “Restore” button to upload and activate the selected configuration.

- 2) **Factory Reset:** Click this button to reset the unit to its factory default settings.
- 3) **System Reboot:** Click the “Reboot” button to force the unit to reboot.
- 4) **Firmware Upgrade:** To update the unit's firmware, click the “Choose File” button to open the file selection window and then select the firmware update file (*.bin format) located on your local PC. After selecting the file, click the “Upgrade” button to begin the firmware update process. Once the process completes the unit will automatically reboot.
- 5) **Serial Number:** Displays the unit's serial number.

6.6 Telnet Control

Before attempting to use Telnet control, please ensure that both the unit and the PC are connected to the same active networks.

Start your preferred Telnet/Console client, or use the built in client provided by most modern computer operating systems. After starting the client, connect by using the current IP address of the unit and port 23 (if the communication port number used by the unit has not been changed previously). This will connect us to the unit we wish to control and commands may now be entered directly.

Note 1: If the IP address of the unit is changed then the IP address required for Telnet access will also change accordingly.

Note 2: This unit defaults to DHCP mode. The current IP address can be verified via RS-232 if the Device Discovery software is not available. The default communication port is 23.

6.7 Serial and Telnet Commands

COMMAND
Description and Parameters
help ←
Show the full command list.
help N1 ←
Show details about the specified command. N1 = {Command}
? ←
Show the full command list.
? N1 ←
Show details about the specified command. N1 = {Command}

COMMAND									
Description and Parameters									
set factory default ↵	Reset the unit to the factory defaults.								
set system reboot ↵	Reboot the unit.								
get fw ver ↵	Show the unit's current firmware version.								
get hw ver ↵	Show the unit's current hard version								
get command ver ↵	Show the unit's current command version.								
set in N1 name N2 ↵	<p>Set the name of the specified input.</p> <p>Available values for N1:</p> <table border="0"> <tr> <td>1</td> <td>[USB-C]</td> </tr> <tr> <td>2</td> <td>[DP]</td> </tr> <tr> <td>3</td> <td>[HDMI 1]</td> </tr> <tr> <td>4</td> <td>HDMI 2]</td> </tr> </table> <p>N2 = {Name} [ASCII, 32 characters max]</p>	1	[USB-C]	2	[DP]	3	[HDMI 1]	4	HDMI 2]
1	[USB-C]								
2	[DP]								
3	[HDMI 1]								
4	HDMI 2]								
get in N1 name ↵	<p>Show the current name of the specified input.</p> <p>Available values for N1:</p> <table border="0"> <tr> <td>1</td> <td>[USB-C]</td> </tr> <tr> <td>2</td> <td>[DP]</td> </tr> <tr> <td>3</td> <td>[HDMI 1]</td> </tr> <tr> <td>4</td> <td>[HDMI 2]</td> </tr> </table>	1	[USB-C]	2	[DP]	3	[HDMI 1]	4	[HDMI 2]
1	[USB-C]								
2	[DP]								
3	[HDMI 1]								
4	[HDMI 2]								

COMMAND	
Description and Parameters	
get in name list ↵	List the names of all inputs on the unit.
set out A name N1 ↵	Set the name of the output. N1 = {Name} [ASCII, 32 characters max]
get out A name ↵	Show the current name of the output.
set out A route N1 ↵	Route the specified input to the output. Available values for N1 : 1 [USB-C] 2 [DP] 3 [HDMI 1] 4 [HDMI 2]
get out A route ↵	Show the current input routed to the output.
set out A mask N1 ↵	Enable or disable the A/V Mask setting on the output. Available values for N1 : ON [Output muted] OFF [Normal output]
get out A mask ↵	Display the current A/V Mask setting for the output.

COMMAND

Description and Parameters

set in N1 hdcp mode N2 ↵

Set the HDCP behavior of the specified input.

Available values for **N1**:

1	[USB-C]
2	[DP]
3	[HDMI 1]
4	[HDMI 2]

Available values for **N2**:

0	[Disabled]
1	[Follow source]
2	[Follow display]

get in N1 hdcp mode ↵

Show the current HDCP behavior used by the specified input.

Available values for **N1**:

1	[USB-C]
2	[DP]
3	[HDMI 1]
4	[HDMI 2]

get in N1 hdcp status ↵

Show the current HDCP status of the specified input.

Available values for **N1**:

1	[USB-C]
2	[DP]
3	[HDMI 1]
4	[HDMI 2]

Possible response values:

0	[No HDCP]
1	[HDCP 1.x]
2	[HDCP 2.2]

COMMAND	
Description and Parameters	
get out A hdcp status ←	
Show the current HDCP status of the HDBaseT output.	
Possible response values:	
0	[No HDCP]
1	[HDCP 1.x]
2	[HDCP 2.2]
get out A hdcp ability ←	
Show the HDCP compliance level of the display device connected to the HDBaseT output.	
Possible response values:	
0	[No HDCP support]
1	[HDCP 1.x only]
2	[HDCP 2.2 only]
get in N1 hdcp ability ←	
Show the HDCP compliance level of the source connected to the specified input.	
Available values for N1 :	
1	[USB-C]
2	[DP]
3	[HDMI 1]
4	[HDMI 2]
Possible response values:	
0	[No HDCP support]
1	[HDCP 1.x only]
2	[HDCP 2.2 only]

COMMAND**Description and Parameters****set all in edid mode N1** ←

Select the EDID management mode to use (All or Appoint) for all inputs.

Available values for **N1**:

ON	[All mode]
OFF	[Appoint mode]

get all in edid mode ←

Show the current EDID management mode used by all inputs.

set all in edid N1 ←

Set the EDID to use when the “All” EDID mode is active.

Available values for **N1**:

1	[FHD, 2CH EDID]
2	[FHD, MCH EDID]
3	[UHD, 2CH EDID]
4	[UHD, MCH EDID]
5	[UHD+, 2CH EDID]
6	[UHD+, MCH EDID]
7	[User EDID 1]
8	[User EDID 2]
9	[User EDID 3]
10	[User EDID 4]
11	[Sink's EDID]

Note: N1 values 5 and 6 cannot be applied to the USB-C input due to bandwidth limitations.

get all in edid ←

Show the current EDID used by the “All” EDID mode.

COMMAND	
Description and Parameters	
set in N1 edid N2 ↵	
Set the EDID to use on the specified input.	
Available values for N1 :	
1	[USB-C]
2	[DP]
3	[HDMI 1]
4	[HDMI 2]
Available values for N2 :	
1	[FHD, 2CH EDID]
2	[FHD, MCH EDID]
3	[UHD, 2CH EDID]
4	[UHD, MCH EDID]
5	[UHD+, 2CH EDID]
6	[UHD+, MCH EDID]
7	[User EDID 1]
8	[User EDID 2]
9	[User EDID 3]
10	[User EDID 4]
11	[Sink's EDID]
<i>Note: N2 values 5 and 6 cannot be applied to the USB-C input due to bandwidth limitations.</i>	
get in N1 edid ↵	
Show the EDID currently being used on the specified input.	
Available values for N1 :	
1	[USB-C]
2	[DP]
3	[HDMI 1]
4	[HDMI 2]
get in edid list ↵	
List all available EDID selections.	

COMMAND	
Description and Parameters	
set edid N1 name N2 ↵	
Set the name for the specified EDID.	
Available values for N1 :	
7	[User EDID 1]
8	[User EDID 2]
9	[User EDID 3]
10	[User EDID 4]
N2 = {Name}	[ASCII, 16 characters max]
<i>Note: Only User EDIDs may be renamed</i>	
get edid N1 name ↵	
Show the current name of the specified EDID.	
Available values for N1 :	
7	[User EDID 1]
8	[User EDID 2]
9	[User EDID 3]
10	[User EDID 4]
set user N1 edid data N2 ↵	
Upload a new EDID (in hex format) for use as the specified User EDID.	
N1 = 1~4	[User EDID]
N2 = {EDID data}	[Comma delimited hex pairs]
get user N1 edid data ↵	
Show the current contents of the specified User EDID as hex data.	
N1 = 1~4	[User EDID]

COMMAND	
Description and Parameters	
get internal N1 edid data ←	
Show the specified Internal EDID as hex data.	
Available values for N1 :	
1	[FHD, 2CH EDID]
2	[FHD, MCH EDID]
3	[UHD, 2CH EDID]
4	[UHD, MCH EDID]
5	[UHD+, 2CH EDID]
6	[UHD+, MCH EDID]
set audio out A route N1 ←	
Route the specified audio source type to the HDBaseT output.	
Available values for N1 :	
1	[Bypass audio]
2	[External audio]
get audio out A route ←	
Show the current audio source type routed to the HDBaseT output.	
set out auto mode N1 ←	
Set the automatic video switching behavior of the unit.	
Available values for N1 :	
0	[Disabled]
1	[Auto switch]
get out auto mode ←	
Show the unit's current automatic video switching mode.	
get ipconfig ←	
Show the unit's current IP configuration information.	

COMMAND					
Description and Parameters					
set ip mode N1 ↵	<p>Set the IP address assignment mode.</p> <p>Available values for N1:</p> <table> <tr> <td>STATIC</td> <td>[Static IP mode]</td> </tr> <tr> <td>DHCP</td> <td>[DHCP mode]</td> </tr> </table>	STATIC	[Static IP mode]	DHCP	[DHCP mode]
STATIC	[Static IP mode]				
DHCP	[DHCP mode]				
get ip mode ↵	<p>Show the current IP address assignment mode.</p>				
set static ipaddr N1 ↵	<p>Set the unit's static IP address.</p> <p>N1 = X.X.X.X [X = 0~255, IP address]</p>				
get static ipaddr ↵	<p>Show the unit's current static IP address.</p>				
set static netmask N1 ↵	<p>Set the unit's static netmask.</p> <p>N1 = X.X.X.X [X = 0~255, Netmask]</p>				
get static netmask ↵	<p>Show the unit's current static netmask.</p>				
set static gateway N1 ↵	<p>Set the unit's static gateway address.</p> <p>N1 = X.X.X.X [X = 0~255, Gateway address]</p>				
get static gateway ↵	<p>Show the unit's current static gateway address.</p>				

COMMAND	
Description and Parameters	
set webgui password N1 ↵	
Set the WebGUI login password.	
N1 = {Password}	[ASCII, 16 characters max]
get webgui password ↵	
Show the current WebGUI login password.	
set webgui login timeout N1 ↵	
Set the WebGUI inactivity timeout value.	
Available values for N1 :	
0	[No timeout]
1~35970	[Timeout in minutes]
get webgui login timeout ↵	
Show the current WebGUI inactivity timeout value.	
set webgui port N1 ↵	
Set the unit's WebGUI access port.	
N1 = 1~65535	[TCP port]
get webgui port ↵	
Show the unit's current WebGUI access port.	
set telnet login N1 ↵	
Enable or disable requiring Telnet logins.	
Available values for N1 :	
ON	[Enabled]
OFF	[Disabled]
get telnet login ↵	
Show the current state of Telnet login allowance.	

COMMAND	
Description and Parameters	
set telnet username N1 ←	
Set the Telnet login username.	
N1 = {Name}	[ASCII, 20 characters max]
get telnet username ←	
Show the current Telnet login username.	
set telnet password N1 ←	
Set the Telnet login password.	
N1 = {Password}	[ASCII, 20 characters max]
get telnet password ←	
Set the unit's Telnet access port.	
set telnet port N1 ←	
Set the unit's Telnet access port.	
N1 = 1~65535	[TCP port]
get telnet port ←	
Show the unit's current Telnet access port.	
get mac addr ←	
Show the unit's MAC address.	

COMMAND	
Description and Parameters	
set automation event N1 cec A N2 ↵	
Enable or disable the specified Automation Event's CEC response.	
Available values for N1 :	
1	[Power on]
2	[Out A source active]
3	[Out A source lost]
Available values for N2 :	
ON	[Event CEC response enabled]
OFF	[Event CEC response disabled]
get automation event N1 cec A ↵	
Show the current state of the specified Automation Event's CEC response.	
Available values for N1 :	
1	[Power on]
2	[Out A source active]
3	[Out A source lost]
set automation event N1 cec A delay N2 ↵	
Set the delay time that the specified Automation Event must continue to be true before sending the defined CEC command.	
Available values for N1 :	
1	[Power on]
2	[Out A source active]
3	[Out A source lost]
N2 = 0~240	[Delay time in seconds]

COMMAND

Description and Parameters

get automation event N1 cec A delay↵

Show the delay time for the specified Automation Event's CEC response.

Available values for **N1**:

- | | |
|---|-----------------------|
| 1 | [Power on] |
| 2 | [Out A source active] |
| 3 | [Out A source lost] |

set automation event N1 cec A wait N2↵

Set the length of time to wait after an Automation Event's CEC response has been activated before ANY other Automation Event can be detected.

Available values for **N1**:

- | | |
|---|-----------------------|
| 1 | [Power on] |
| 2 | [Out A source active] |
| 3 | [Out A source lost] |

N2 = 0~240 [Wait time in seconds]

get automation event N1 cec A wait↵

Show the wait time for the specified Automation Event's CEC response.

Available values for **N1**:

- | | |
|---|-----------------------|
| 1 | [Power on] |
| 2 | [Out A source active] |
| 3 | [Out A source lost] |

COMMAND	
Description and Parameters	
set automation event N1 cec A command N2	
Set the CEC command to send when the specified Automation Event is activated.	
Available values for N1 :	
1	[Power on]
2	[Out A source active]
3	[Out A source lost]
Available values for N2 :	
0	[Power off]
1	[Power on]
2	[Active Source]
3	[Power On+Out A src active]
get automation event N1 cec A command	
Show the CEC command to be sent when the specified Automation Event is activated.	
Available values for N1 :	
1	[Power on]
2	[Out A source active]
3	[Out A source lost]
set automation event N1 uart A N2	
Enable or disable the specified Automation Event's RS-232 response.	
Available values for N1 :	
1	[Power on]
2	[Out A source active]
3	[Out A source lost]
Available values for N2 :	
ON	[Event RS-232 response enabled]
OFF	[Event RS-232 response disabled]

COMMAND	
Description and Parameters	
get automation event N1 uart A ↵	
Show the current state of the specified Automation Event's RS-232 response.	
set automation event N1 uart A command N2 ↵	
Set the RS-232 command string to send when the specified Automation Event is activated.	
Available values for N1 :	
1	[Power on]
2	[Out A source active]
3	[Out A source lost]
N2 = {command}	[ASCII, 32 characters maximum]
get automation event N1 uart A command ↵	
Show the RS-232 command string to be sent when the specified Automation Event is activated.	
Available values for N1 :	
1	[Power on]
2	[Out A source active]
3	[Out A source lost]
set automation event N1 uart A delay N2 ↵	
Set the delay time that the specified Automation Event must continue to be true before sending the defined RS-232 command.	
Available values for N1 :	
1	[Power on]
2	[Out A source active]
3	[Out A source lost]
N2 = 0~240	[Delay time in seconds]

COMMAND	
Description and Parameters	
get automation event N1 uart A delay ←	
Show the delay time for the specified Automation Event's RS-232 response.	
Available values for N1 :	
1	[Power on]
2	[Out A source active]
3	[Out A source lost]
set automation event N1 uart A wait N2 ←	
Set the length of time to wait after an Automation Event's RS-232 response has been activated before ANY other Automation Event can be detected.	
Available values for N1 :	
1	[Power on]
2	[Out A source active]
3	[Out A source lost]
N2 = 0~240	[Wait time in seconds]
get automation event N1 uart A wait ←	
Show the wait time for the specified Automation Event's RS-232 response.	
Available values for N1 :	
1	[Power on]
2	[Out A source active]
3	[Out A source lost]

COMMAND**Description and Parameters****set automation event N1 uart A endchar N2**

Set the termination character(s) to attach after the specified command in the command pool.

Available values for **N1**:

1	[Power on]
2	[Out A source active]
3	[Out A source lost]

Available values for **N2**:

0	[None]
1	[CR]
2	[LF]
3	[CR+LF]

get automation event N1 uart A endchar

Show the current termination character(s) used by the specified command in the command pool.

Available values for **N1**:

1	[Power on]
2	[Out A source active]
3	[Out A source lost]

set uart 2 baudrate

Set the baud rate of the Bypass RS-232 port.

Available values for **N1**:

4800	[4800 baud]
7200	[7200 baud]
9600	[9600 baud]
14400	[14400 baud]
19200	[19200 baud]
38400	[38400 baud]
57600	[57600 baud]
115200	[115200 baud]

COMMAND	
Description and Parameters	
get uart 2 baudrate ↵	Show the current baud rate of the Bypass RS-232 port.
set uart 2 stop bit N1 ↵	Set the number of stop bits for the Bypass RS-232 port. Available values for N1 : 1 [1 Stop Bit] 2 [2 Stop Bits]
get uart 2 stop bit ↵	Show the current number of stop bits of the Bypass RS-232 port.
set uart 2 data bit N1 ↵	Set the data bits for the Bypass RS-232 port. Available values for N1 : 5 [5 Data Bits] 6 [6 Data Bits] 7 [7 Data Bits] 8 [8 Data Bits]
get uart 2 data bit ↵	Show the current number of data bits of the Bypass RS-232 port.
set uart 2 parity N1 ↵	Set the parity of the Bypass RS-232 port. Available values for N1 : 0 [Disable] 1 [Odd] 2 [Even]
get uart 2 parity ↵	Show the current parity setting of the Bypass RS-232 port.

COMMAND	
Description and Parameters	
get hdbt out A cable test ↵	<p>Show the cable test result for the HDBaseT output.</p> <p><i>Note: Uses the highest available source resolution without exceeding 4K@60Hz 4:2:0</i></p>
get hdbt out A cable state ↵	<p>Show the cable state data from the HDBaseT output.</p>
get hdbt out A local hardware type ↵	<p>Show the local hardware type details from the HDBaseT output.</p>
get hdbt out A remote hardware type ↵	<p>Show the remote hardware type details from the HDBaseT output.</p>
set hostname N1 ↵	<p>Set the unit's hostname.</p> <p>N1= {Name} [ASCII, 15 characters max]</p>
get hostname ↵	<p>Show the unit's current hostname.</p>
set feedback broadcast N1 ↵	<p>Enable or disable the broadcast of console command feedback.</p> <p>Available values for N1:</p> <p>ON [Enable]</p> <p>OFF [Disable]</p>
get feedback broadcast ↵	<p>Show the current console command feedback broadcast state.</p>

COMMAND	
Description and Parameters	
set nickname N1 ↵	
Set the unit's nickname.	
N1 = {Name}	[ASCII, 16 characters max]
get nickname ↵	
Show the unit's current nickname.	
set usb host auto mode N1 ↵	
Set the automatic USB host switching behavior of the unit.	
Available values for N1 :	
ON	[Enable]
OFF	[Disable]
get usb host auto mode ↵	
Show the current automatic USB host switching behavior of the unit.	
set usb host N1 route 1 ↵	
Set the active USB Host port.	
Available values for N1 :	
1	[Local Host (Type-B)]
2	[Local Host (Type-C)]
3	[Remote Host]
get usb host N1 route ↵	
Show the currently active host port.	

Note: Commands will not be executed unless followed by a carriage return. Commands are not case-sensitive.

7. CONNECTION DIAGRAM

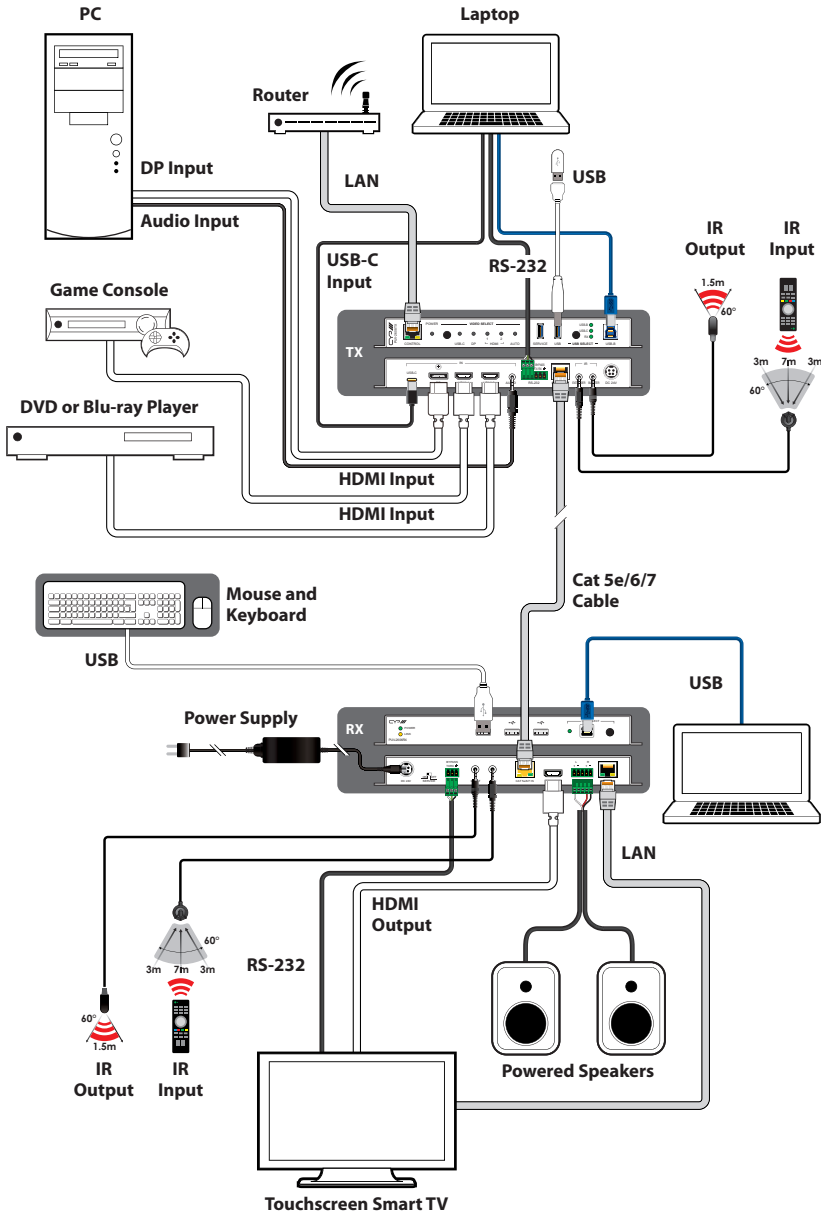

8. SPECIFICATIONS

8.1 Technical Specifications

HDMI Bandwidth	18Gbps
DisplayPort Bandwidth	21.6Gbps
USB-C Bandwidth	21.6Gbps
HDBaseT Bandwidth	10.2Gbps
Input Ports	1×USB 3.0 (Type-C) 1×DisplayPort 2×HDMI (Type-A) 1×Analog Stereo (3.5mm)
Output Ports	1×HDBaseT (RJ-45)
Pass-through Ports	1×IR In (3.5mm) 1×IR Out (3.5mm) 1×RS-232 (3-pin Terminal Block) 1×USB 3.0 (Type-A) 1×USB 3.0 (Type-B)
Pass-through/Control Port	1×IP Control (RJ-45)
Pass-through/Service Port	1×USB 3.0 (Type-A)
Control Port	1×RS-232 (3-pin Terminal Block)
IR Frequency	30 ~ 50kHz (30 ~ 60kHz under ideal conditions)
Baud Rate	Up to 115200 (19200 for control)
Power Supply	24V/3.75A DC or PoH (US/EU standards, CE/FCC/UL certified)
ESD Protection (HBM)	±8kV (Air Discharge) ±4kV (Contact Discharge)
Dimensions (W×H×D)	213.5mm×25mm×108mm [Case Only] 213.5mm×25mm×116mm [All Inclusive]
Weight	671g

Chassis Material	Metal (Steel)
Chassis Colour	Black
Operating Temperature	0°C – 50°C/32°F – 122°F
Storage Temperature	-20°C – 60°C/-4°F – 140°F
Relative Humidity	20 – 90% RH (Non-condensing)
Power Consumption	45W (When not providing USB-C power) 106W (When providing USB-C power)

8.2 Video Specifications

Supported Resolutions (Hz)	Input			Out-put
	HDMI	DP	USB-C	HDBT
720x400p@70/85	✓	✗	✗	✓
640x480p@60/72/75/85	✓	✓	✓	✓
720x480i@60	✓	✗	✗	✓
720x480p@60	✓	✓	✓	✓
720x576i@50	✓	✗	✗	✓
720x576p@50	✓	✓	✓	✓
800x600p@56/60/72/75/85	✓	✓	✓	✓
848x480p@60	✓	✗	✗	✓
1024x768p@60/70/75/85	✓	✓	✓	✓
1152x864p@75	✓	✓	✓	✓
1280x720p@50/60	✓	✓	✓	✓
1280x768p@60/75/85	60/70	60/70	60/70	60/70
1280x800p@60/75/85	60	60	60	60
1280x960p@60/85	✓	✓	✓	✓
1280x1024p@60/75/85	✓	✓	✓	✓
1360x768p@60	✓	✓	✓	✓
1366x768p@60	✓	✓	✓	✓
1400x1050p@60	✓	✗	✗	✓
1440x900p@60/75	✓	✓	✓	✓
1600x900p@60RB	✓	✓	✓	✓
1600x1200p@60	✓	✗	✗	✓
1680x1050p@60	✓	✓	✓	✓
1920x1080i@50/60	✓	✓	✗	✓

Supported Resolutions (Hz)	Input			Out-put
	HDMI	DP	USB-C	HDBT
1920×1080p@24/25/30	✓	✓	✓	✓
1920×1080p@50/60	✓	✓	✓	✓
1920×1200p@60RB	✓	✓	✓	✓
2560×1440p@60RB	✓	✗	✗	✓
2560×1600p@60RB	✓	✗	✗	✓
2048×1080p@24/25/30	✗	✗	✗	✗
2048×1080p@50/60	✓	✗	✗	✓
3840×2160p@24/25/30	✓	✓	✓	✓
3840×2160p@50/60 (4:2:0)	✓	✗	✗	✓
3840×2160p@24, HDR10	✗	✗	✗	✗
3840×2160p@50/60 (4:2:0), HDR10	✗	✗	✗	✗
3840×2160p@50/60	✓	✓	✗	✗
4096×2160p@24/25/30	✓	✓	✓	✓
4096×2160p@50/60 (4:2:0)	✓	✗	✗	✓
4096×2160p@24, HDR10	✗	✗	✗	✗
4096×2160p@50/60 (4:2:0), HDR10	✗	✗	✗	✗
4096×2160p@50/60	✓	✓	✗	✗

8.3 Audio Specifications

8.3.1 Digital Audio

HDMI/DisplayPort/USB-C Inputs	
LPCM	
Max Channels	8 Channels
Sampling Rate (kHz)	32, 44.1, 48, 88.2, 96, 176.4, 192
Bitstream	
Supported Formats	Standard & High-Definition
HDBaseT Output	
LPCM	
Max Channels	8 Channels
Sampling Rate (kHz)	32, 44.1, 48, 88.2, 96, 176.4, 192
Bitstream	
Supported Formats	Standard & High-Definition

8.3.2 Analog Audio

Analog Input	
Max Audio Level	2Vrms
Impedance	34kΩ
Type	Unbalanced

8.4 Cable Specifications

Cable Length	HD	FHD	4K UHD	4K UHD ⁺	8K UHD
High Speed HDMI Cable					
HDMI Input	10m	10m	5m	5m	×
DisplayPort Cable					
DisplayPort Input	2m				×
USB-C Cable					
USB-C Input	2m				×
Ethernet Cable					
Cat.5e/6	100m		90m		×
Cat.6A/7	100m		100m		×

Bandwidth Category Examples:

HD Video

- 720p@60Hz
- HDMI transmission rates lower than 3Gbps
- HD-SDI (SMPTE 292M, 1.485Gbps)

FHD Video

- 1080p@60Hz
- HDMI transmission rates between 3Gbps and 5.3Gbps
- 3G-SDI (SMPTE 424M, 2.970Gbps)

4K UHD Video

- 4K@24/25/30Hz (8-bit colour) & 4K@50/60Hz (4:2:0, 8-bit colour)
- HDMI transmission rates between 5.3Gbps and 10.2Gbps
- 6G-SDI (SMPTE ST 2081, 6Gbps)

4K UHD⁺ Video

- 1080p@120Hz (10/12-bit HDR)
- 4K@50/60Hz (4:4:4, 8-bit) & 4K@50/60Hz (4:2:0, 10/12-bit HDR)
- HDMI transmission rates between 10.2Gbps and 18Gbps
- 12G-SDI (SMPTE ST 2082, 12Gbps)

8K UHD Video

- 4K@120Hz (10/12-bit HDR)
- 8K@24/25/30Hz (10/12-bit HDR) & 8K@50/60Hz (4:2:0, 8-bit colour)
- HDMI transmission rates between 18Gbps and 48Gbps
- 24G-SDI (SMPTE ST 2083, 24Gbps)

8.5 HDBaseT Features

HDBaseT Feature Set	Transmitter
Video & Audio Extension	Supported
LAN Extension	Supported
Send power to Receiver	Unsupported
Accept power from Receiver	Supported (PoH)
IR Extension	Supported
RS-232 Extension	Supported
USB 2.0 Extension	Supported

9. ACRONYMS

ACRONYM	COMPLETE TERM
4K UHD	4K Ultra-High-Definition (10.2Gbps max)
4K UHD⁺	4K Ultra-High-Definition (18Gbps max)
8K UHD	8K Ultra-High-Definition (48Gbps max, without DSC)
8K UHD⁺	8K Ultra-High-Definition (48Gbps max, with DSC)
ADC	Analog-to-Digital Converter
ASCII	American Standard Code for Information Interchange
Cat.5e	Enhanced Category 5 cable
Cat.6	Category 6 cable
Cat.6A	Augmented Category 6 cable
Cat.7	Category 7 cable
CEC	Consumer Electronics Control
dB	Decibel
DHCP	Dynamic Host Configuration Protocol
DP	DisplayPort
DVI	Digital Visual Interface
EDID	Extended Display Identification Data
GbE	Gigabit Ethernet
Gbps	Gigabits per second
GUI	Graphical User Interface
HDBT	HDBaseT
HDCP	High-bandwidth Digital Content Protection
HDMI	High-Definition Multimedia Interface
HDR	High Dynamic Range
IP	Internet Protocol

ACRONYM	COMPLETE TERM
IR	Infrared
kHz	Kilohertz
KVM	Keyboard/Video/Mouse
LAN	Local Area Network
LED	Light-Emitting Diode
LPCM	Linear Pulse-Code Modulation
MAC	Media Access Control
MHz	Megahertz
PD	Powered Device
PoH	Power over HDBaseT
PSE	Power Sourcing Equipment
SNR	Signal-to-Noise Ratio
TCP	Transmission Control Protocol
THD+N	Total Harmonic Distortion plus Noise
TMDS	Transition-Minimised Differential Signaling
USB	Universal Serial Bus
VGA	Video Graphics Array
WUXGA (RB)	Widescreen Ultra Extended Graphics Array (Reduced Blanking)
XGA	Extended Graphics Array
Ω	Ohm



CYP (UK) Ltd., Unit 7, Shepperton Business Park, Govett Avenue,
Shepperton, Middlesex, TW17 8BA

Tel: +44 (0) 20 3137 9180 | Fax: +44 (0) 20 3137 6279

Email: sales@cypeurope.com

www.cypeurope.com

RDV1